



# **Amulet Ultra Dual Mono**

## **User Guide Blend and Panorama**

**First of all**, thank you for purchasing what we feel is the finest acoustic guitar pickup system available today. As you use your Amulet Ultra, we're quite sure you'll feel the same way!

**The Amulet Ultra Dual Mono Blend and Panorama complete systems consist of:**

- Acoustic Lens™ Pickup (*pair*) assembly plus install items (see the [Acoustic Lens pickup installation guide](#) for details)
- Soundhole-mounted Ultra Dual Mono Preamp
- Endpin/Battery Clip assembly
- Cable clips
- Battery bag
- **Custom Shop Options:** Amulet Ultra Dual Mono Blend and Panorama Upgrade Kits (preamp & endpin assembly with a pickup input adapter - see Page 17)



**Please read through all of these instructions before installing your system and [contact us](#) with any questions!**

Each Amulet Ultra Dual Mono Preamp has 2 thumbwheel controls - Blend has Master Volume, plus a Volume control for the pickup in Channel 2 (with our Acoustic Lenses, typically the Treble pickup) Panorama has a Master Volume control, plus a Balance thumbwheel control that pans between Channel 1 and 2 (see Page 4). We recommend that you make sure the master volume thumbwheel is set to a lower (or off) position when plugging into an amplifier, and then adjust to your desired volume to avoid any unpleasant surprises.

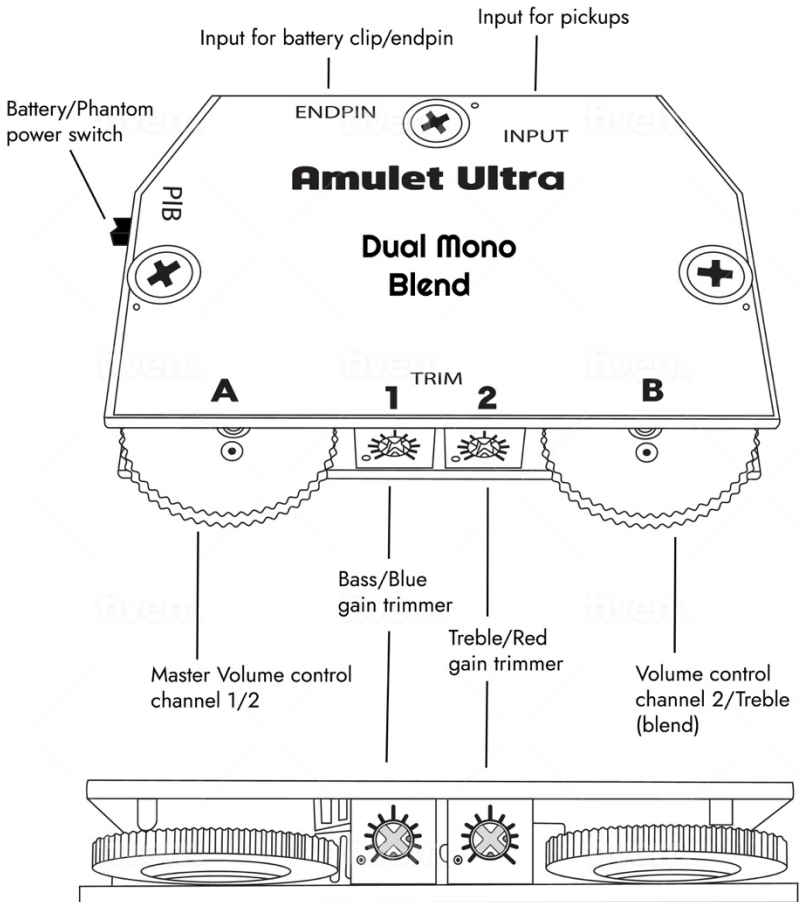

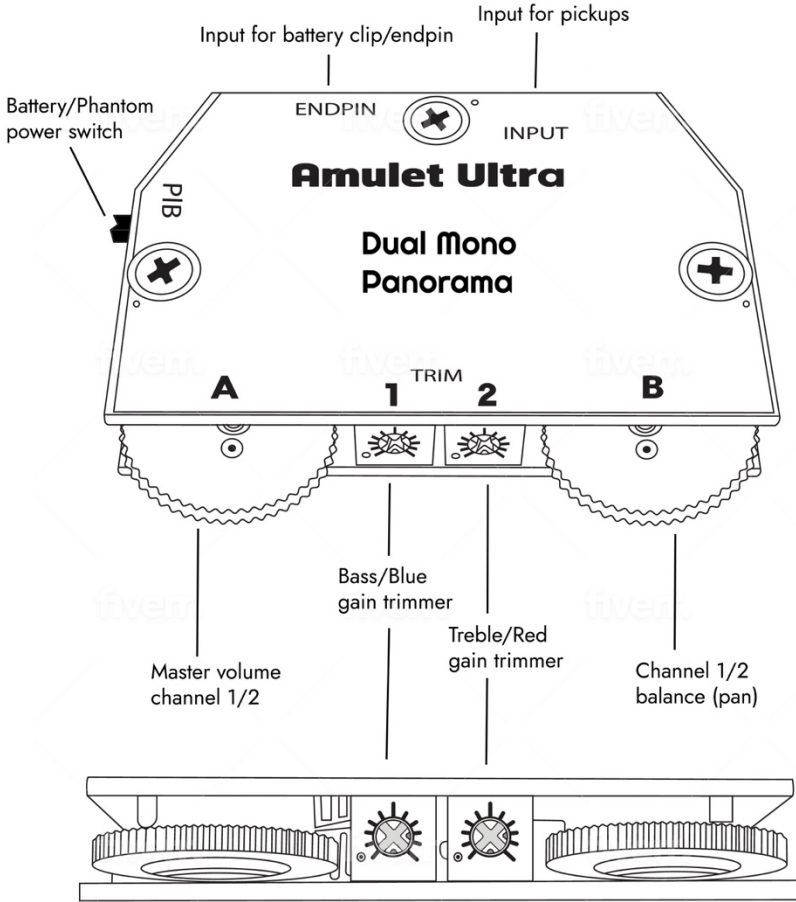

Always hold the preamp by the top and bottom especially when unhooking from the velcro

**DO NOT** hold or pull on the preamp by the thumbwheel - This will damage your preamp

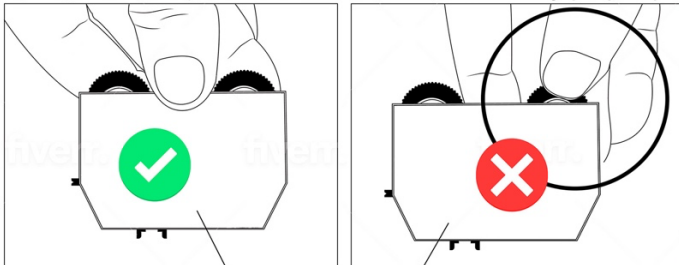

Bottom of Amulet Ultra preamp - velcro side

## The Amulet Ultra system inside your guitar

*Install the battery bag on or near the neck block for easy battery access*

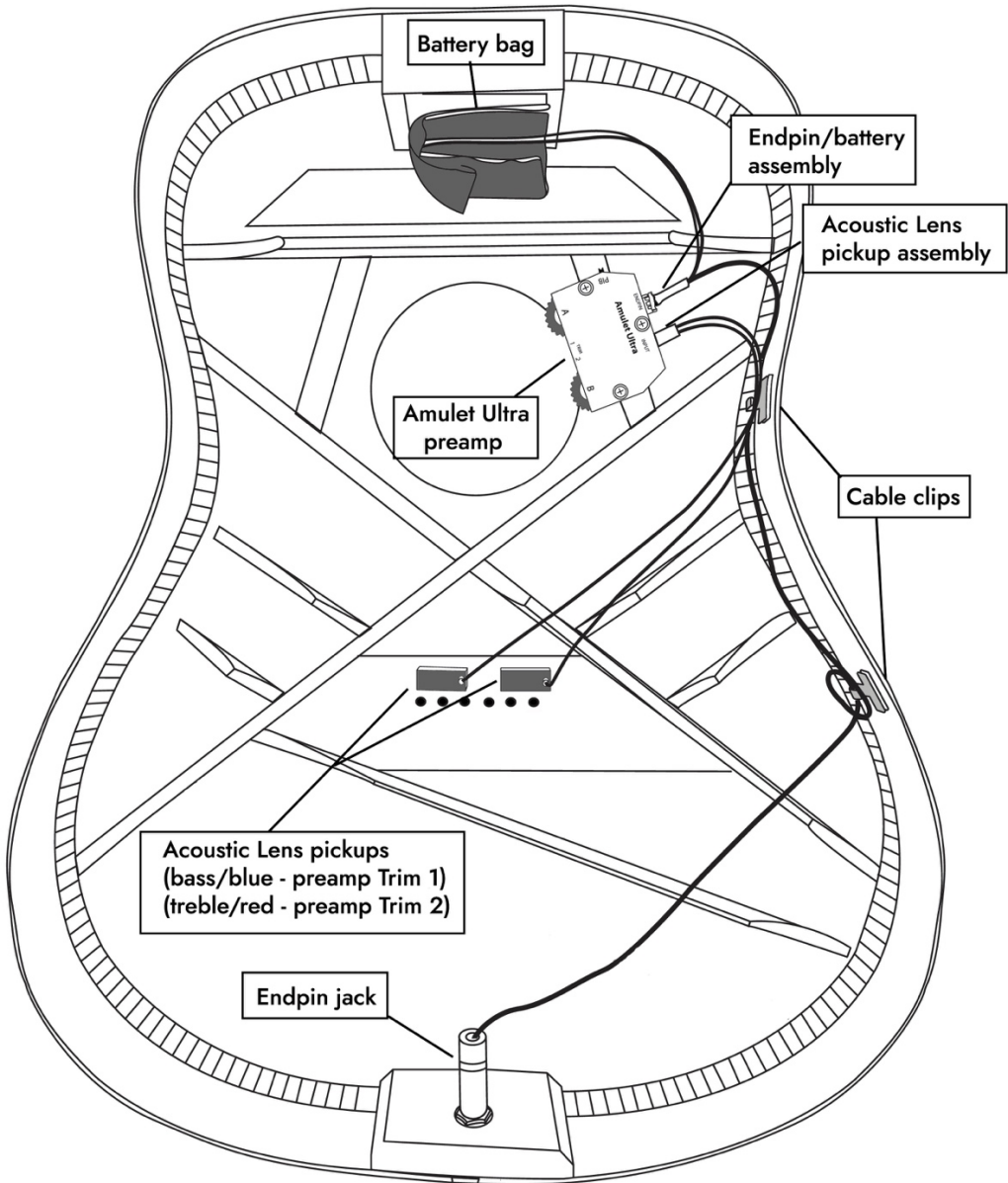

## INSTALLING YOUR AMULET ULTRA SYSTEM

For detailed pickup installation instructions, please see our guide at <https://tranceaudio.com/support/>

It is very important to prepare the surface of the guitar in any spot where you are going to apply adhesives, whether it is the Velcro patch used for the battery bag and preamp, the stick-on cable clips, or the pickups themselves. The surfaces inside a guitar collect dust and dirt, and the process of finishing a guitar will often leave behind sawdust as well as lacquer or other types of spray.

After deciding where the adhesive parts are going to be placed, prepare these surfaces by lightly sanding them with 100 grit sandpaper on a small sanding block to remove any surface contamination. Blow out any dust using compressed air if possible, and wipe these surfaces with a small clean cloth that has been very lightly moistened with water or Windex to pick up any remainder. Let these areas dry completely (at least a half an hour) before applying the adhesive items. Not cleaning and preparing the surface will cause premature failure of the adhesive.



## **MOUNTING THE PREAMP**

The Amulet Ultra preamp module is extremely lightweight, and so it's fairly easy to securely mount it to the bass side of the soundhole on most guitars using the Velcro supplied with the system. Most guitars will have a brace mounted near the soundhole, and this brace varies a lot in size and location. Some braces are flat and thin, while others are rounded or taller, and some may be quite close to the soundhole, while others are located farther away.

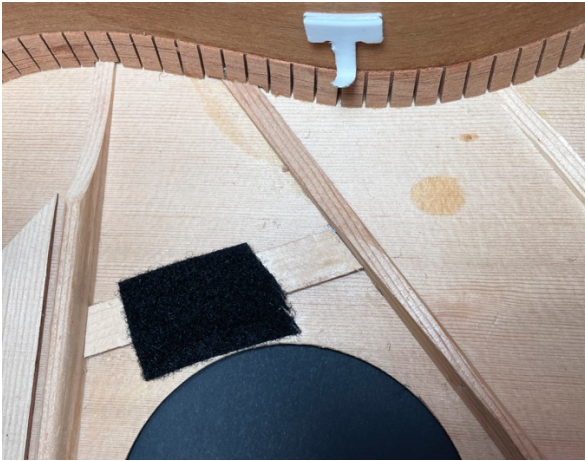

The preamp does not need to grip the entire surface of the Velcro to create a firm attachment, so you can easily use the surface of the brace to help tip the preamp thumbwheels toward the outer surface of the soundhole, bringing the wheels closer to the top of the instrument at a slight angle which makes them easier to access while playing.

The ideal mounting situation is to have the Velcro on the front of the preamp attached at the front of the soundhole, while the middle or back of the preamp is attached to the Velcro covering the soundhole brace, tipping the preamp thumbwheels toward the edge of the soundhole.

Once the two Velcro surfaces are mated, wiggling the preamp back and forth and twisting it slightly will create a better connection between the Velcro hooks and loops and a more secure mounting for the preamp.

The preamp modules have the hook portion of the Velcro already applied, so the loop portion of the Velcro is applied at the soundhole; the loop material is much softer and more pliable, so it is easier to apply and mold over the inside top and braces around the soundhole to create a proper surface to securely mount the preamp module.

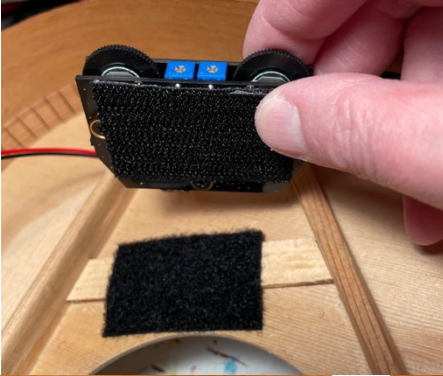

Once you've created a proper mounting location for the preamp, you can plug the endpin connector and the input connector into their respective locations (see Page 9), set the power slide switch on the side to your preferred mode of operation (see Page 12), and install the preamp module securely in place. Wiggle and twist it a bit to help lock the Velcro together, and use the provided wire clips to secure the cables so they don't rattle around and create noise during your performance.





The Pickup Input Assembly and Endpin/Battery Clip Assembly jacks have a keyed design so that it only plugs in correctly with the plug oriented in ONE DIRECTION.

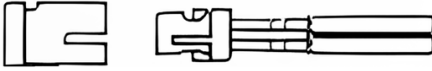

This is called a polarized connector, and it insures that all of the cable wires get hooked up correctly during installation. *To ensure that you can easily and correctly install the endpin and pickup plugs, they each have a silver stripe printed on top of the connector. Make sure this stripe is facing up when you install the connectors to correctly orient them into the preamp jacks.*

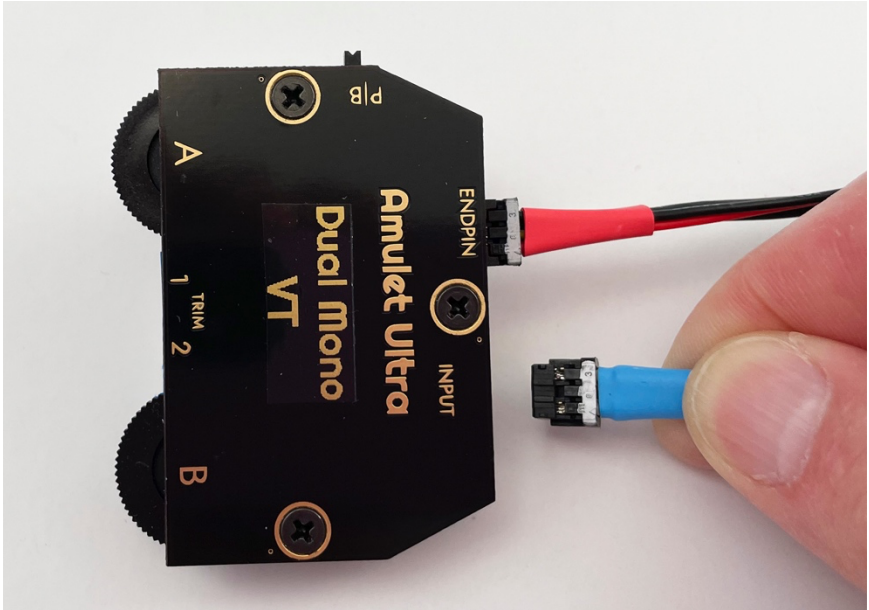



The endpin connector socket is easily visible at the left rear of the unit, while the input connector socket for the pickups is recessed somewhat inside the unit, directly lined up with the “INPUT” label on the top cover of the unit.

You can use the colored heatshrink tubing at the connector as a handle to help guide it into place inside the

unit, directly over the printing on the top cover. When correctly aligned, you will feel the connector slide into place and lock. It helps to practice this a few times with the pickup and endpin assemblies before they are installed in the instrument to get a sense of how the connectors feel when properly installed.

**To unplug the connectors**, pull gently on the heatshrink handles near the connectors and wiggle them from side to side lightly until the connector unlocks and is removed.

## TRIM CONTROL

Each preamp channel has its own easily accessible gain trimmer that allows you to set the perfect balance between the pickups. These can also be used to match the level of your instrument to your amplification system, and even match levels between multiple instruments allowing for smooth transitions between instruments during a performance. This control can be adjusted using the provided 3mm Phillips head screwdriver or a small flat-bladed screwdriver or a (up to) #1 size Phillips head screwdriver. Like any regular trimmer, there are mechanical stops at each end of the rotation, so take care when adjusting not to try to force it past its limits, or you will damage it.

The gain trimmers for the pickups are easily accessible at the edge of the soundhole, allowing for quick and easy adjustments even after the system has been installed.

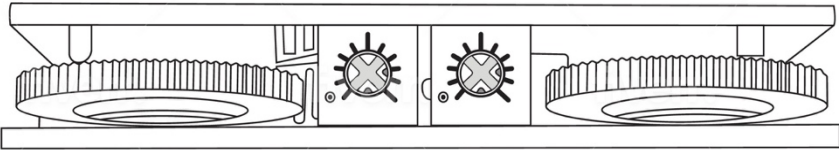

- Turning the trimmer to the right (CW) will increase the gain, and turning to the left (CCW) will decrease the gain
- Careful adjustment will allow you to tune in the exact balance between the bass and treble strings of your instrument
- The adjustment range is typically 18db, which is wide enough to set any desired balance between pickups
- Trimmer 1 adjusts the Channel 1 (bass side/blue) pickup, and Trimmer 2 adjusts the Channel 2 (treble side/red) pickup.

**Note:** The frequency response of the preamplifier channels is identical, and the blue/red pickups can be used on either bass/treble with no change in performance, if preferred.

The Trimmers are set at the factory to the center position, which is typically a good starting point. *With the thumbwheel volume control(s) set to maximum volume*, you can adjust the trimmers up or down to the desired balance and overall volume for your particular setup.

## **USING THE TRIM CONTROLS - GAIN STAGING YOUR SYSTEM**

The gain trimmers adjust the amount of gain available from the preamp; turning the trimmer clockwise (CW) increases the overall gain, and turning it counter clockwise (CCW) decreases the overall gain. These are not volume controls, so turning the trimmer fully CCW will not shut off the preamp channel output.

If you're using our Acoustic Lens transducers, then the channel 1 and 2 blue gain trimmers on the front of the unit should be turned completely CW. You can then make adjustments to set the balance between the two pickups as desired.

**BATTERY POWER:** When using your Ultra system with a standard 1/4" mono guitar cable, plug it into the Line input of your mixer or audio interface and set the input for standard (non-HiZ) operation if this option is available. Set the preamp Volume thumbwheel(s) all the way up, and play as loudly as you intend to during your performance or recording, and adjust the gain trim (if available) on your mixer or audio interface channel to get the maximum amount of gain without clipping. If there is a meter or clipping LED, adjust the gain until it is just flashing on the loudest strums, then turn it down a bit until the LED stops flashing.

**PHANTOM POWER:** When using a Mixer or audio interface to Phantom Power the Ultra, the XLR input you're plugging into is a microphone channel and will have a large amount of gain available since it's usually used to amplify the very small signal from most microphones. For proper operation, be sure to set the gain trimmers for these MIC channels so that they can accept the much larger line level signal from the Ultra preamp. This typically involves turning the channel gain trimmers fully CCW.

You can also use the trimmers to balance the overall volume between multiple instruments. This can be very useful if you play several different guitars during a show; the trimmers can be used to adjust the level of a louder guitar to match the level of the other instruments to make changes during a set easier when swapping guitars.

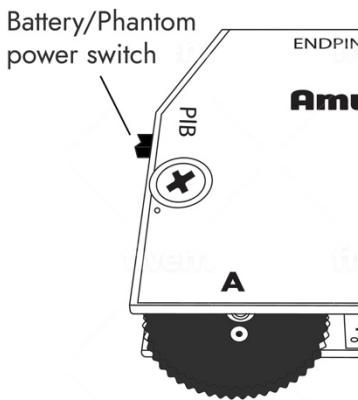

## POWERING THE SYSTEM -

### Battery/Phantom Power Switch

Your Amulet Ultra preamp can be powered by a single 9V battery when the switch is set to B (towards the thumbwheel controls), or by 48v Phantom power when set to P (towards the rear of the preamp). Once a new battery is attached to the battery cable, make sure it is secured in the battery bag with the Velcro closure securely fastened, so it won't come loose inside the instrument while performing. *Note: If you have a*

*battery installed, you do not need to remove it when using the Phantom power option; the battery will be shut off when the switch is in the Phantom position.*

### Cable – for Battery power, use a standard Mono (1/4" TS) guitar cable

The endpin serves as the on/off switch for the system when using battery power so remember to unplug your cable from the guitar when not in use in order to preserve battery life.

### Cable - for Phantom Power - use a 1/4" TRS (stereo) to male XLR cable

With the Battery/Phantom power switch set to Phantom, the Amulet Ultra preamp is designed to work with 48 volt phantom power. The preamp will not work with lower phantom power voltages such as 24 or 12 volts. While this lower voltage might be useful for some types of small microphones, it will not power the Amulet Ultra correctly, so be sure and check the manufacturer's info for any unit that you are considering for use with our system. See Page 18 for more info on phantom power.

## ENDPIN JACK INSTALLATION

The endpin jack serves as the audio output of the system, the power on/off switch, and also as the strap button where you can secure the back of the strap for your instrument. When using a battery to power the system, be sure to unplug the cable when not in use to preserve battery life.

**PLEASE NOTE:** For installation of the Amulet Ultra endpin jack, your guitar must have a standard size endpin jack hole (1/2"). *If your guitar does not already have an endpin jack hole, this must be added by a professional luthier or an experienced guitar repair technician as damage to your instrument can result if done incorrectly.*

The Amulet Ultra's endpin can accommodate an endblock depth up to 7/8". This isn't an issue for most modern guitars, but some older instruments may have thicker endblocks. If needed, [you can check the endblock depth yourself](#).

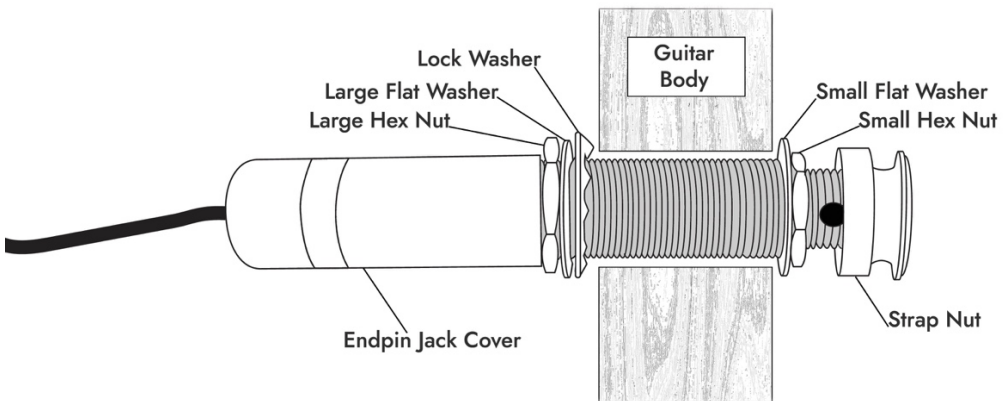

**Remove the Strap Nut, the Small Hex Nut and the Small Flat Washer from the Amulet Ultra endpin assembly.**



From inside the guitar, insert the endpin assembly through the endblock hole, making sure not to allow the Large Flat Washer and the Locking Washer to fall off. Adjust the Large Hex Nut so the larger threads are about  $1/16''$  shy of the outside of the endblock.

Thread the Small flat Washer and Small Hex Nut, then insert a  $3/32''$  (2.3 mm) or smaller diameter shaft

through the small hole at the front of the endpin shaft (a small screwdriver or drill bit should work well for this).



Tighten the nut with a  $1/2''$  open end or crescent wrench while you hold the jack in place and keep it from turning with the small screwdriver, drill bit, etc. Then install and hand tighten the Strap Nut.



**Note:** When properly installed, the end of the jack will be flush or slightly ahead of the strap nut, so when a plug is inserted, it will snap securely in place. If the end of the jack is recessed too much, the cable plug will not plug in all the way and engage properly, and may even fall out.

Adjust the Large Hex Nut to achieve a proper fit of the Strap Nut when installed.

Once the endpin is properly installed, screw the Endpin Jack Cover on as far as it will go to lock it in place and keep it from rattling.





## ULTRA UPGRADE

If you're upgrading your old Amulet system or using another manufacturer's pickups, you'll have an input adapter assembly with jacks for you to plug your pickups into. Plug the input adapter assembly connector into the preamp input (see Page 9 for details on the keyed plug design).

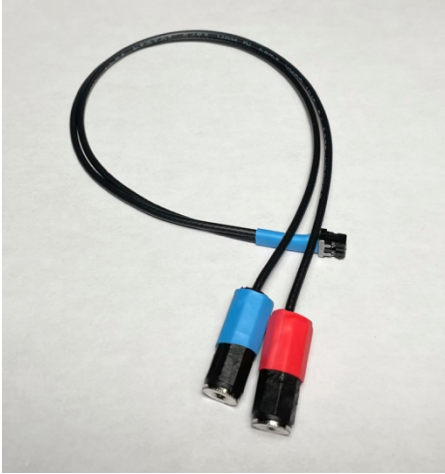

To keep the plugs from your pickups and the jacks of the input adapter assembly from rattling around in your guitar, attach the jack and plug assembly to the inside back of your guitar using velcro.

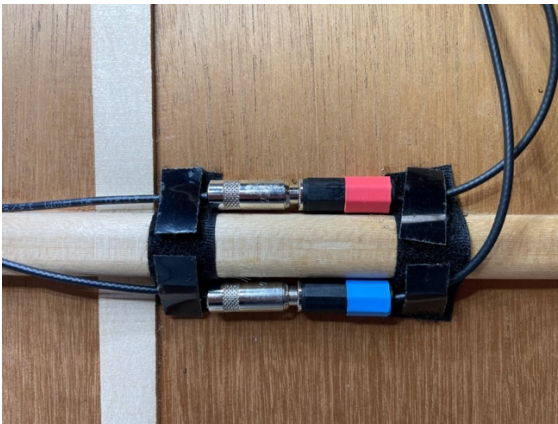
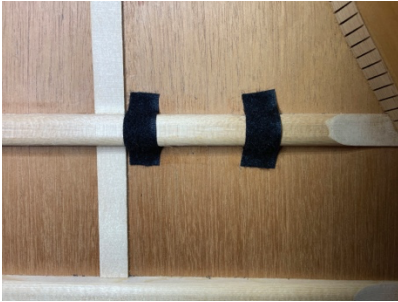

## PHANTOM POWER

Most modern mixers have 48 volt phantom power built into their microphone preamp channels. This means that you can plug the Amulet Ultra directly into the mic input of your mixer, turn on 48V phantom power and play. Some devices advertise phantom power capabilities, but actually have lower phantom voltages which will not power our system, so be sure to carefully examine any manufacturers literature for any device you are considering for this purpose. There are also instances where a device may provide 48 volt phantom power, but at a much lower than usual current capability (just enough to power a small microphone) and will not properly power our system. This is usually only the case with very inexpensive gear. If you're not using a mixer or other device that has the necessary 48 volt phantom power, there are low-cost standalone phantom power supply units that are available from a variety of sources. These typically have an input and output XLR connector, a connector for a plug in power adapter, and internal electronics to supply phantom power.



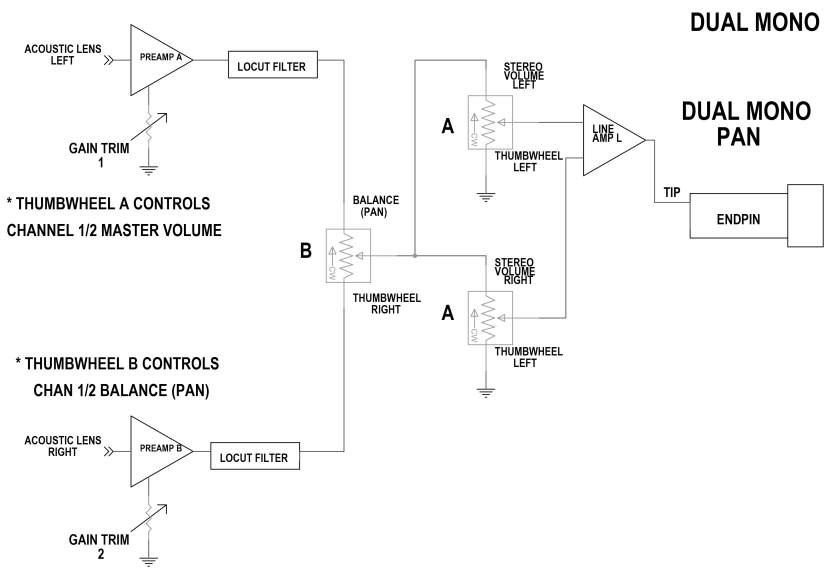
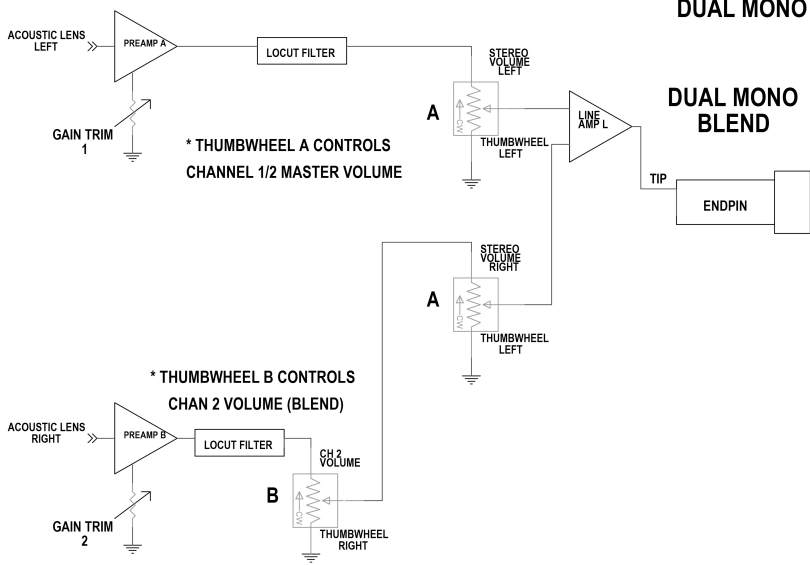

## **THE AMULET ULTRA™**

### **Warranty**

This warranty covers all defects in materials and workmanship for a period of one (1) year from the date of purchase by the original owner. Cases may arise where our Service Department or one of Trance Audio's authorized service centers will ask for a copy of your sales receipt to facilitate warranty service. Please keep your purchase receipt in a safe place.

Trance Audio® does not cover:

- Damages due to improper or inadequate maintenance, accident, abuse, misuse, alteration, unauthorized repairs, tampering, or failure to follow normal operating procedures as outlined in the owner's manual.
- Damages occurring during any shipment of the product for any reason.
- Any product that has been modified by anyone other than Trance Audio, Inc.

### **Limitation of Implied Warranties**

The warranty described in this one year warranty shall be in lieu of any other warranty, expressed or implied, including but not limited to, any implied warranty of merchantability or fitness for a particular purpose.

### **Exclusion of Certain Damages**

Trance Audio's liability for a product found defective is limited to repair or replacement of the unit, at our option. In no event shall Trance Audio be liable for damages based on inconvenience, whether incidental or consequential, loss of use of the unit, loss of time, interrupted operation or commercial loss, or any other consequential damages.

Some states do not allow limitation of the duration of implied warranties or the exclusion or limitation of incidental or consequential damages, so the above limitations and exclusions may not apply to you.

### **How To Obtain Warranty Service**

All Trance Audio products are manufactured with the highest standards of quality. If you find that your transducer or preamp does require service, it may only be done by the Trance Audio service center. Please contact Trance Audio at - Tel: 1(831)688-9699 email: info@tranceaudio.com.

When returning a product to the factory, you will be issued a Return Authorization number. Please label all cartons, shipping documents and correspondence with this number.

### **CAUTION**

Trance Audio recommends that Acoustic Lens and Amulet Ultra® installation be done by a professional luthier or guitar repair technician.

Installers: Please read the install instructions carefully, and please contact us by phone or email with any questions. We will not be responsible for any damage to the guitar or personal injury resulting from installation of this product.

© 2024 Trance Audio, Inc.® USA All Rights Reserved

Tel: (831) 688-9699 email: info@tranceaudio.com | [tranceaudio.com](http://tranceaudio.com)